

Data Sheet



Article number: 1080401031000

Description: Servocontroller ACU401-03-FA
0,37 kW 1,6A 3x400V IP20

Measures

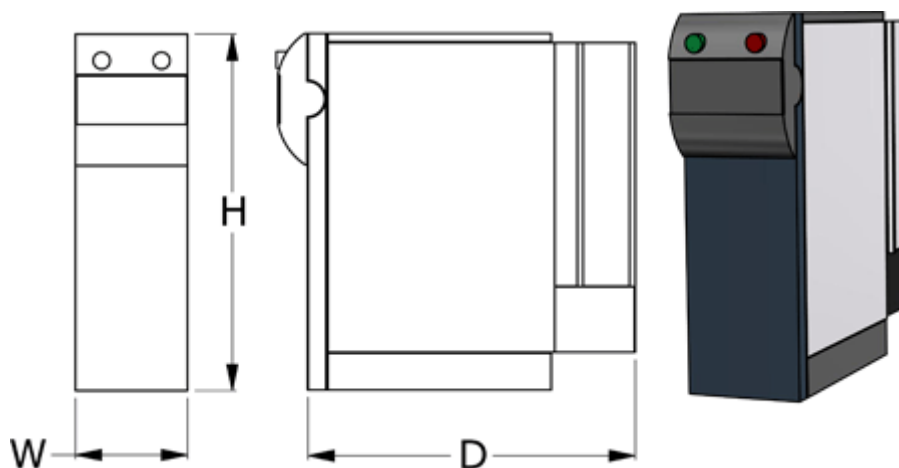

D = 175
H = 190
W = 60
Weight = 1.2